

Smart Workflow **x** High Productivity
Network Storage and Computing System

TS-x53B Series

2 / 4 / 6-bay NAS

Equipped with One PCIe Expansion Slot Unlimited Possibilities

QM2 M.2 SSD / 10GbE Network Expansion Card

- Supports SSD caching and Qtier, a high-efficiency auto-tiering storage system



Performance Boost

Dual-port USB 3.1 Gen2 10Gbps Type-A Expansion Card

- Enables lightning-fast transmission. Compatible with USB 3.0 and 2.0 devices.



Dual-band 2.4 GHz/5 GHz PCI Express Network Expansion Card

- Turns your NAS into a wireless base station, allowing devices to quickly access NAS resources using Wi-Fi



Enhanced Performance



DLNA™ ubuntu



TS-653B

- ◆ USB Type-C QuickAccess port for accessing files without needing a network connection.
- ◆ Equipped with quad-core Intel® Celeron® J3455 processor, which can burst up to 2.41 GHz.
- ◆ Supports AES-NI encryption and accelerated video decoding and transcoding.
- ◆ A hybrid approach to virtualization: Virtualization Station, Linux Station, and Container Station, with remote access support.
- ◆ QTS 4.3 provides File Station for managing files and data, QmailAgent as a centralized email manager, and Qcontactz for storing contact information.
- ◆ Features an OLED screen, touch-sensitive buttons, speaker with verbal system warnings, and easy-to-access internals with tool-less hard drive installation.



TS-253B



TS-453B



TS-653B



DDR3L
4GB / 8GB



Speaker



3.5mm
Mic In x 2



4K 2K UHD
QvPC
Technology

TS-x53B

Network Storage and Computing System

Small in size
Big in features

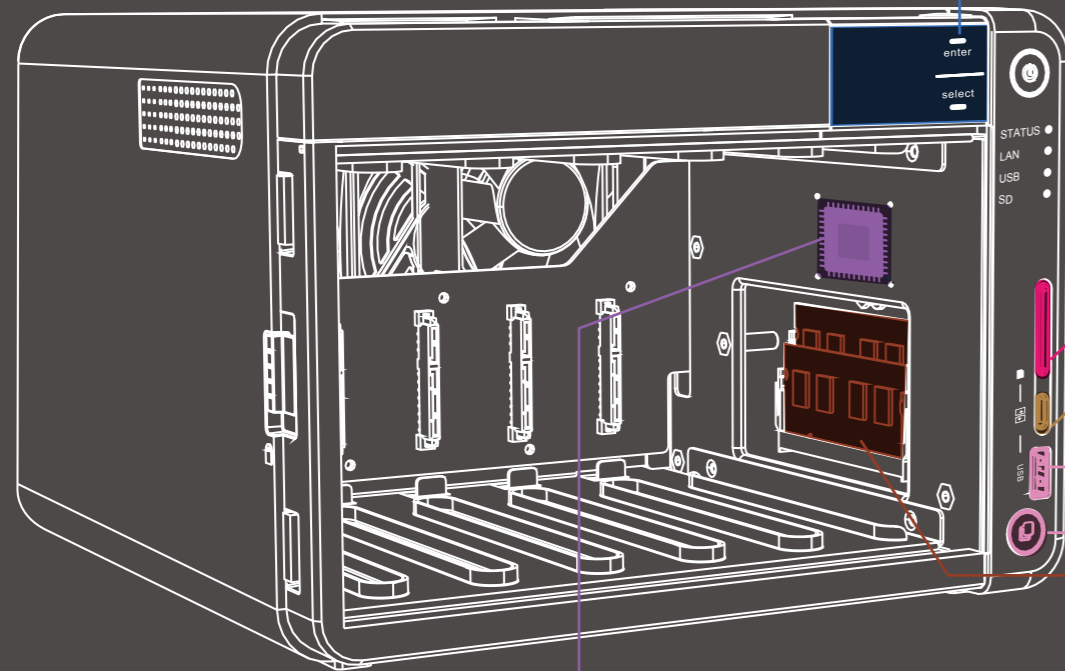

06 Front cover with magnets and lock

- Quick disassembly and dust prevention

07 Quad-core Intel® Celeron® J3455 1.5 GHz processor, bursting up to 2.3 GHz

- 9th-generation HD Graphics processor and 4K hardware-accelerated video transcoding engine
- AES-NI encryption engine

01 OLED screen and touch-sensitive buttons

- Monitor the system status with ease

02 USB-C QuickAccess (USB-C QuickAccess)

- Connect to the PC or Mac with USB-C cables and use Qfinder Pro to quickly complete first-time installation, and access NAS data without complicated network configurations

03 SD card slot

- Easily back up photos

04 USB 3.0 port and one-touch-copy button

- Press the "Copy" button to instantly back up data

05 Up to 8GB DDR3L memory

- 2 x SODIMM memory slots

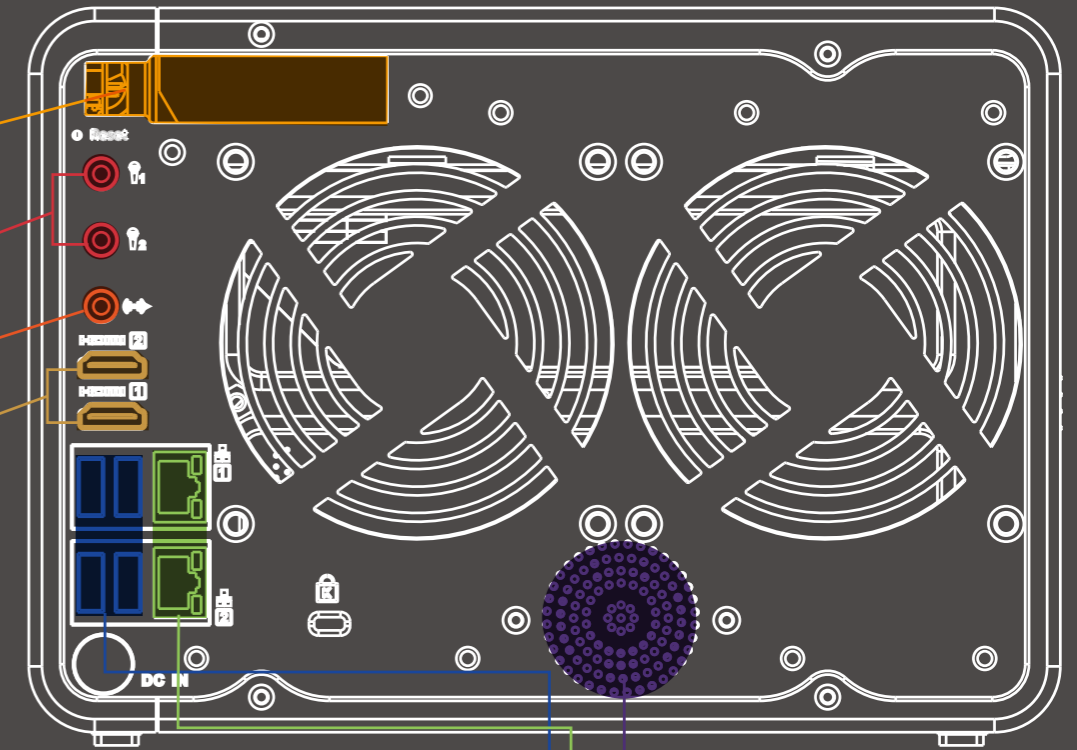

08 1 x PCIe expansion slot

- Can be expanded with QM2 M.2 SSD/10GbE expansion card, 10GbE network expansion card, USB 3.1 expansion card, and wireless expansion card

09 2 x 3.5 mm microphone jacks

- Supports dynamic microphones

10 3.5 mm Line Out

- Can directly play music files on the NAS by connecting to external speakers

11 2 x 4K HDMI ports

- HDMI 1.4b for displaying up to 3840 x 2160
- Supports duplicated and extended desktop options

12 Built-in speaker

- Music playback
- Verbal system warnings

13 4 x USB 3.0 ports

- Supports external hard drives, printers, and UPS

14 2 x Gigabit ports

- Application service streaming to ensure service bandwidth

Expansion card installation

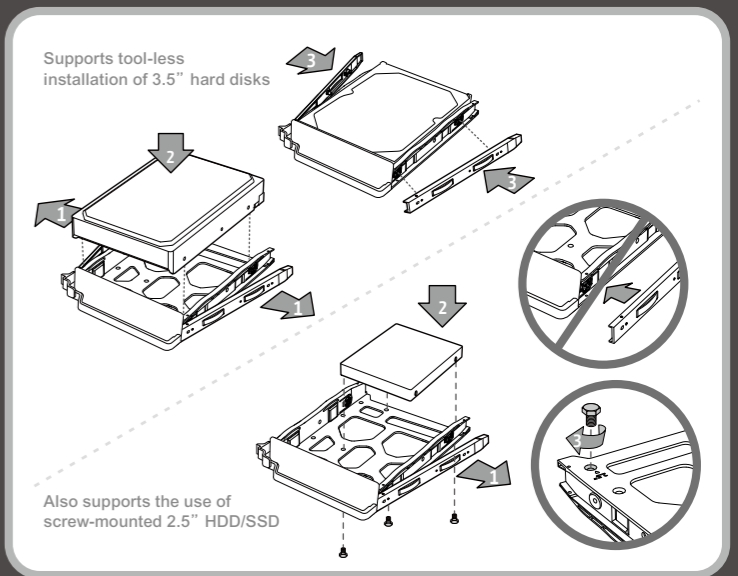
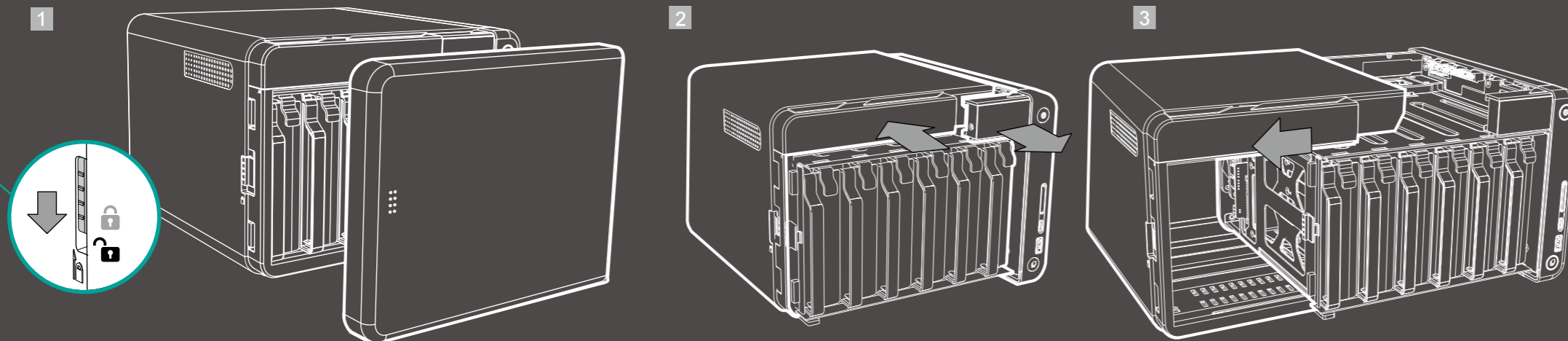

Hardware overview

Powered by Intel® Celeron® quad-core processor and encryption acceleration engine

TS-x53B uses the latest 14nm Intel® Celeron® J3455 quad-core 1.5 GHz (up to 2.3 GHz) processor and 4GB/8GB DDR3L dual channel RAM (expandable to 8GB). With two built-in Gigabit Ethernet ports and SATA 6Gb/s support, the TS-x53B provides up to 224MB/s continuous read/write performance for quick and smooth running of tasks. TS-x53B has a built-in AES-NI encryption engine using AES-256-bit encryption acceleration technology for NAS volume encryption or folder encryption and can maintain up to 224MB/s data read/write speed, so it is able to protect important information in the TS-x53B while maintaining the system's high performance and security at the same time. Users can also install a 10GbE network adapter using the PCIe slot for compatibility with 10GbE networks.

File Transfer (2 x GbE)

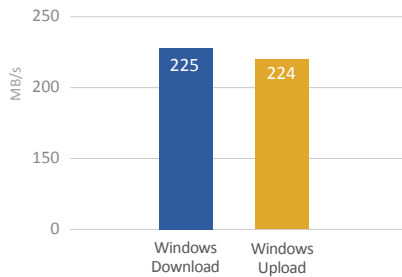

File Transfer with Encryption (2 x GbE)

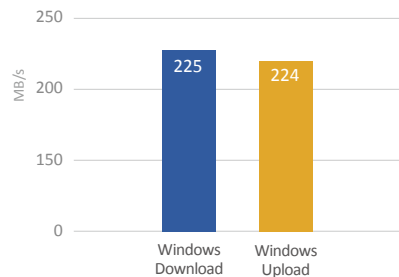

Tested in QNAP laboratories. Data may vary due to differences in physical environments.

Test environment:
 NAS: TS-453B
 OS: QTS 4.3.2
 Disk groups: RAID 5; 4 x Seagate 1TB ST1000NM0033
 HDDs; direct connection between NAS and PCs
 Client PC:
 Intel® Core™ i7-4770 3.40GHz CPU; DDR3L 1600Hz 16GB;
 WD 1TB WD10EZEX;
 Intel Gigabit CT (MTU 1500) ; Windows® 7 Professional
 64bit SP1 & Windows 8.1 Pro 64-bit
 IOMeter settings: switch between multiple PCs, transfer 32GB files for 3 minutes. Block size: 64KB, SMB2.0

OLED display and touch-sensitive buttons

The TS-x53B has a new contemporary design with a simple and elegant appearance. The tool-less installation of 3.5-inch hard disks makes the installation process a breeze. The OLED screen shows the TS-x53B status for users to easily view system status, storage capacity, temperature, volume, and other information. The capacitive touch-sensitive buttons allow users to control the NAS, including power options, network IP settings and host password.



USB-C QuickAccess, plug and play

The TS-x53B uses USB-C QuickAccess to simplify NAS setup. Connect the USB Type-C cable* to your PC and use Qfinder Pro** for first-time installation and setup. USB-C QuickAccess can also be used to directly access data stored in the TS-x53B. Connect your Windows/Mac computer to the USB-C QuickAccess port on the TS-x53B front panel, find TS-x53B in Qfinder Pro and finish the installation. No complex network settings are required. You can also flexibly set up access permissions to ensure data security.

* USB-C cable sold separately.

** Qfinder Pro and USB QuickAccess only support Windows 8, 10 (and later) and Mac OS 10.7 (or later). Some operating systems may require additional drivers.

Low-cost, flexible storage expansion

The TS-x53B can be connected to a QNAP expansion enclosure to scale up the storage capacity (Raw Capacity)* online without downtime and easily managed with QTS Storage Manager. This easy expansion makes the TS-x53B suitable for applications in data-intensive industries, such as surveillance video storage, mass data storage or TV archival storage. With QJBOD Express**, you can connect a TS-x53B to a suitable QNAP expansion enclosure (UX-500P or UX-800P) to quickly transfer data to another storage expansion device supported by NAS without going through a network. VJBOD (Virtual JBOD) allows users to maximize their storage utilization by expanding the capacity of a QNAP NAS using the unused storage space of another QNAP NAS.

* To expand storage space using an UX Expansion Enclosure, you must create a separate static volume or storage pool on the UX Expansion Unit.

** RAID groups for storage pools can not be spread across multiple expansion devices.

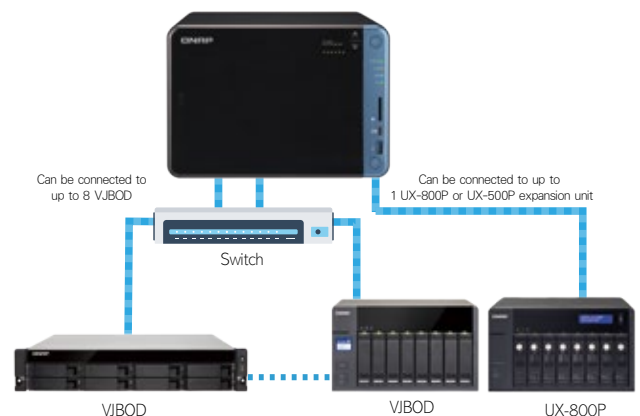

4K video conversion and HDMI output

The TS-x53B features Intel® 9th generation HD Graphics for 4K video playback (HDMI) and transcoding, making it a complete multimedia center for direct audiovisual output*. Transcoding allows videos to be easily converted to universal formats and resolutions for playing on multiple devices and in bandwidth-constricted areas. The Linux Station app allows users to directly download from the Ubuntu Software Center, providing apps such as Plex Media Server, KMPlayer, LibreOffice, VLC and other playback software. The TS-x53B also features an integrated HD Station app and support for third-party players (such as Plex Home Theater) that can be used when the NAS is connected to an HDTV or A/V receiver to directly play the multimedia files stored on the TS-x53B. TS-x53B has dual HDMI output, and supports either "mirrored" or "extended" display. The Qremote mobile app can convert your mobile devices into convenient remote controls.

* Multimedia playback capability may vary according to the application, device, and network environment.



PCIe expansion slot for multiple storage applications

The TS-x53B is equipped with a PCIe expansion slot, which allows you to configure multiple applications as needed. A 10GbE PCIe NIC can be installed to connect your TS-x53B NAS to 10GbE networks, a wireless network card can be installed to provide wireless base station functionality, or a USB 3.1 10Gbps card can be installed to connect to USB devices. You can also use M.2 SSDs to enable QNAP Qtier* auto-tiered storage and SSD caching on the TS-x53B. Qtier maximizes storage performance by automatically moving frequently-accessed "hot" data to high-performance volumes (SSD) and less-accessed "cold" data to high-capacity volumes.

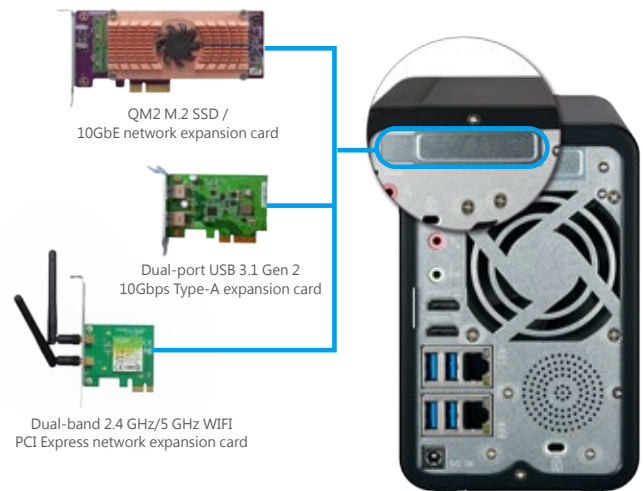

Maximize your NAS performance and utilization with QM2, a M.2 SSD/10GbE LAN PCIe expansion card

The QM2 is a PCIe card that adds support for ultra-fast M.2 SSDs and 10GbE connectivity (optional) to a QNAP NAS*, effectively enhancing NAS storage performance and file transmission stability. Up to two M.2 22110/2280 SSDs can be installed to create a RAID 1 or RAID 0 caching pool to boost performance, or a storage volume to optimize storage efficiency with Qtier. Combining SSD and 10GbE connectivity into one solution, the QM2 can help you construct a 10GbE networking environment and carry out bandwidth-demanding operations.

* QM2-2S10G1T and QM2-2P10G1T only

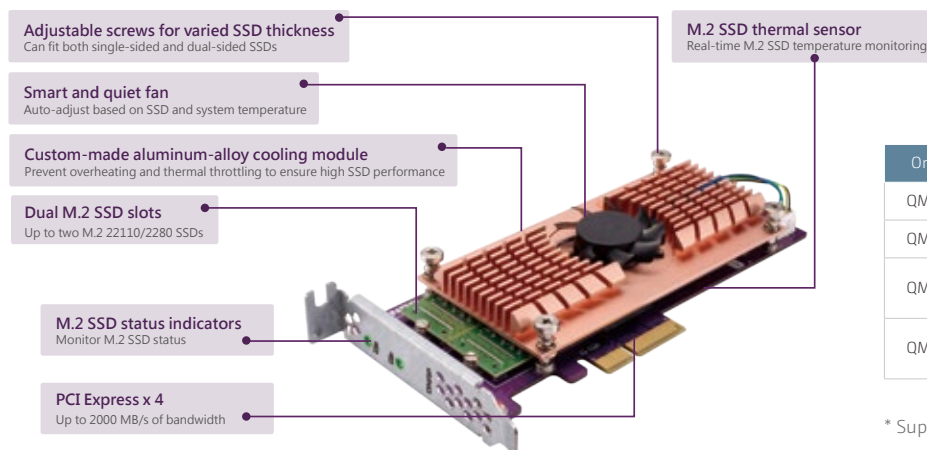

Ordering SKUs	Specifications
QM2-2S	Supports two M.2 2280 / 22110 SATA SSD
QM2-2P	Supports two M.2 2280 / 22110 PCIe SSD
QM2-2S10G1T	Supports two M.2 2280 SATA SSD and one single-port 10GBASE-T 10GbE connection
QM2-2P10G1T	Supports two M.2 2280 PCIe SSD and one single-port 10GBASE-T 10GbE connection

* Supported in QTS 4.3.3 (or later)

Computing and storage system core

QTS 4.3 - The ultimate user experience

The new QTS 4.3 operating system dramatically improves multitasking efficiency and enables users to work in multi-window, multi-desktop, and multi-display modes. You can start new tasks without completing the ones in hand. QTS 4.3 provides numerous applications to fit enterprise requirements, personal productivity and multimedia entertainment. With new smart agent services data and system management is more flexible and automatic for optimum management efficiency. QTS 4.3 provides apps for collaborative notetaking, centralized email management, contacts management, and other productivity boosters. Other features such as the Qsirch full-text search engine and Qfiling's automatic archiving feature greatly assist in daily NAS management tasks.

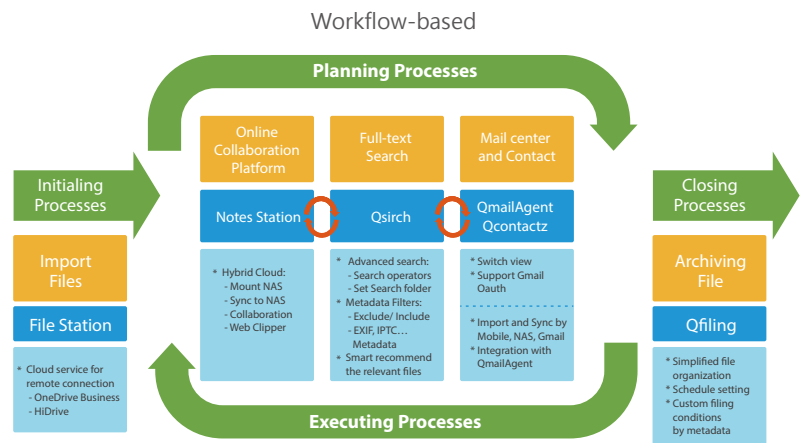

IFTTT Agent - Workflow automation to improve work efficiency

IFTTT (If This Then That) is currently the most popular network automation service, which allows you to freely connect various network-related devices or services to create a variety of simple and powerful workflows. Once you have bound your IFTTT account with your TS-x53B, you can create a variety of small services to automate tasks. For example, you can set the trigger condition as "when a photo is added" and set response action as "download photos to TS-x53B", so you can automatically back up photos to your NAS. With a wide range of triggers and actions, IFTTT Agent can greatly simplify daily tasks with greater automation.

File management

Hybrid Backup Sync - Quick solution for local, remote and cloud backups

Hybrid Backup Sync is a comprehensive backup solution to efficiently manage storage space for all devices on the LAN, across remote-site NAS units and cloud services. Hybrid Backup Sync supports multi-version backup, flexible work scheduling, file compression backup and more.

File Station - Easy-to-use file manager

In addition to viewing the files on the TS-x53B, File Station allows accessing external devices for the easy management of all your files from a single interface. File Station can also access another NAS and cloud storage accounts by using remote mounting.



Qfiling - Simplified file organization

Qfiling automates your file organization. All you need to do is categorize your files, set a schedule, and Qfiling will do the rest. After setting up Qfiling, the files in selected folders will be automatically archived into folders for these categories. Qfiling also offers different conditions for different file types, including document assistant, music guru and video wizard, so you can quickly complete archiving tasks through customized archiving conditions.

Multimedia entertainment

Cinema28 - Streaming management center

Cinema28 is an all-new application that provides a management center for your streaming devices. With Cinema28, you can easily manage all your devices. For example, you can know who is streaming, and what is playing on the smart TV in your living room. It supports 8 types of streaming and playback devices, including music playback: HDMI audio output, Line out audio output, USB speakers, Bluetooth speakers. Video playback includes HDMI, DLNA devices, AirPlay devices, and Chromecast devices.

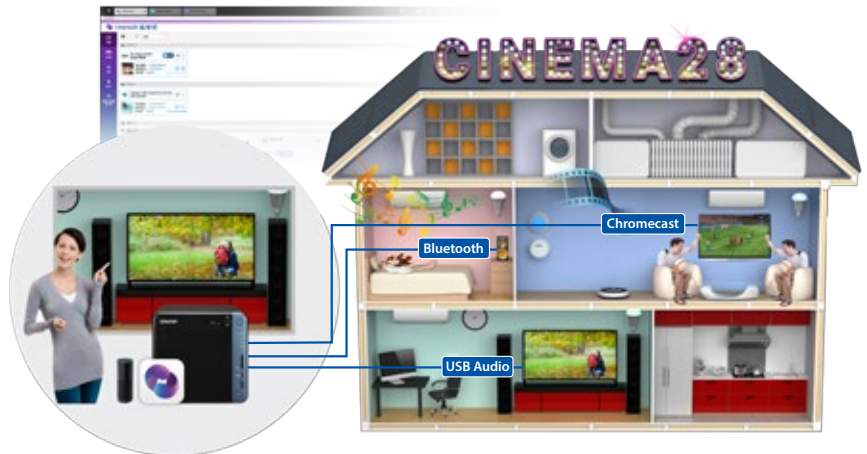

The TS-x53B is a photographer's best friend

Photographer A: The storage capacity is never enough! My photos are all stored in RAW file format, so my SD cards quickly reach their capacity. Even when saved to my computer, RAW files take up too much computer storage space...

Photographer B: I want to quickly back up my photos. Photography is for moment catching, and every picture is precious. How do I save my photos in a good manner?

The TS-x53B supports exFAT-based devices with the purchase of an additional license. An SD card slot is featured on the front panel of the TS-x53B for quick and easy access. By connecting your computer to the TS-x53B's USB-C QuickAccess port, you can easily back up the photos and files on your computer to your NAS.

The photos stored in TS-x53B can then be managed using the Photo Station app. Photo Station is a brilliant app for managing and sharing all of the photos on your TS-x53B. It is easy to use and you can quickly share photos with family, friends, and clients. The mobile app Qphoto allows you to access your photos using your mobile devices. Qphoto can also automatically save new photos taken with your device to your TS-x53B for saving the storage space of your mobile device.



Security monitoring solution



Surveillance Station - Build a professional surveillance system

Surveillance Station is a professional network security monitoring solution that creates a dedicated video storage space and operating environment on the TS-x53B. Surveillance Station has a user-friendly interface, is compatible with over 3,000 IP camera models, and has scalable camera channel license for building and expanding a professional surveillance system. The mobile app Vmobile can be used to monitor your channels from anywhere using mobile devices. With QvPC's "Surveillance Station (Local Display)" function, you can directly view live video feeds or existing footage on an HDMI display. The TS-x53B offers 4 free IP camera channel licenses, and up to 40 channels can be purchased to expand your surveillance system.

* TS-x53B also supports a new surveillance solution, QVR Pro (Beta). You can download it from the QTS App Center.

IoT applications

QIoT Suite Lite - rapid development of an IoT private cloud

QIoT Suite Lite can quickly deploy a variety of IoT applications, helping to save time and allowing developers put their creative ideas into practice. It supports MQTT, HTTP and CoAP and provides MQTTs and HTTPs, so developers need not worry about connection security when using the TS-x53B as a private cloud IoT Center for other network services such as smart devices and smart home applications.

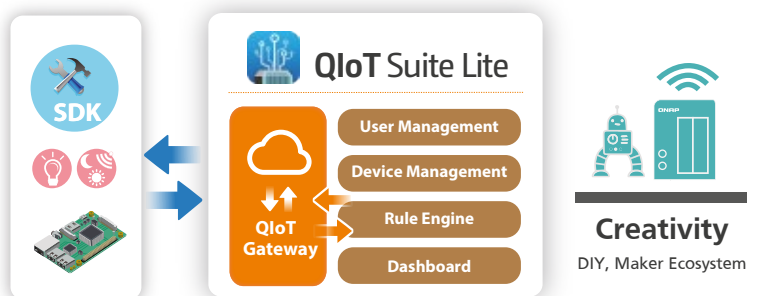

Hardware Specifications



TS-653B



TS-453B



TS-253B

Ordering SKUs	TS-653B-8G	TS-653B-4G	TS-453B-8G	TS-453B-4G	TS-253B-8G	TS-253B-4G
CPU	Intel® Celeron® J3455 quad-core 1.5 GHz, up to 2.3 GHz					
Encryption Acceleration	✓, (AES-NI)					
Graphics	Intel® HD Graphics 500					
System Memory	8GB DDR3L (2 x 4GB)	4GB DDR3L (2 x 2GB)	8GB DDR3L (2 x 4GB)	4GB DDR3L (2 x 2GB)	8GB DDR3L (2 x 4GB)	4GB DDR3L (2 x 2GB)
Maximum Memory	8GB					
Total Memory Slots	2 x DDR3L SODIMM slots (For dual-DIMM configurations, you need to install a pair of DDR3 memories with the same speed, capacity, and chip)					
Supported Drive Type	6 x 3.5"/2.5" SATA 6Gb/s HDD/SSD		4 x 3.5"/2.5" SATA 6Gb/s HDD/SSD		2 x 3.5"/2.5" SATA 6Gb/s HDD/SSD	
Gigabit LAN ports	2 x Gigabit RJ45 LAN ports					
10GbE LAN Port	Optional 10GbE PCIe expansion card sold separately					
USB 3.0 Ports	5 x USB 3.1 Type-A ports					
USB QuickAccess	USB Type-C					
PCIe Slots	1 x PCIe 2.0 x2 slot					
HDMI Ports	2, up to 3846 x 2160, 30 Hz					
Audio	2 x 3.5 mm microphone jacks, 3.5 mm line out jack					
OLED Display	0.96" Mono-OLED display					
LED Indicators	Power/Status, LAN, USB, SD card, drives					
Button	Power/Status, USB one-button-backup, System reset, capacitive touch-sensitive buttons					
Other Slots	SD card reader, Kensington security slot					
Dimension (H x W x D)	168 x 235 x 226 mm 6.61 x 9.25 x 8.90 inch		168 x 170 x 226 mm 6.61 x 6.69 x 8.90 inch		168 x 105 x 226 mm 6.61 x 4.13 x 8.90 inch	
Net Weight	3.01 kg (6.64 lbs)		2.33 kg (5.14 lbs)		1.66 kg (3.66 lbs)	
Operating Temperature	0 to 40°C (104 to 104°F)					
Power Consumption	HDD sleep: 20.62W Typical operation: 40.33W		HDD sleep: 15.00W Typical operation: 30.04W		HDD sleep: 13.07W Typical operation: 20.42W	
Power	120W AC adapter, 100-240V		90W AC adapter, 100-240V		65W AC adapter, 100-240V	
Fan	2 x 9 cm		1 x 12 cm		1 x 7 cm	

Package Contents

NAS, adapter, power cable, Quick Installation Guide, 2 x 1GbE cables, 2.5" drive installation screws

Please refer to www.qnap.com for the latest information.

Design and specifications are subject to change without notice.

Software Specifications

Supported Disk Group Types	TS-253B: RAID 0/1, single, JBOD; TS-453B: RAID 0/1/5/6/10, RAID 1/5 + spare, single, JBOD; TS-653B: RAID 0/1/5/6/10, RAID 1/5/6/10 + spare, single, JBOD
Storage Manager	Flexible disk area and LUN configuration; online storage pool RAID capacity expansion and configuration migration
Supported Client Systems	Windows 7, Windows 8, Windows 10, Windows Server 2003/2008 R2/2012/2012R2, Apple Mac OS 10.6+, Linux and UNIX
Internal File System	EXT4
External File System	EXT4, EXT3, NTFS, HFS+, FAT32, exFAT* *Additional exFAT license required
Supported Protocols	CIFS/SMB, AFP (v3.3), NFS(v3), FTP, FTPS, SFTP, TFTP, HTTP(S), Telnet, SSH, iSCSI, SNMP, SMTP, and SMC
File Sharing	Maximum number of users: 4096; Maximum number of user groups: 512; Maximum shared folders: 512; Maximum simultaneous connections: 800
Video Surveillance	Surveillance Station supports 4 free camera groups. You can purchase additional license to expand to a maximum of 40 groups (http://license.qnap.com)
Other Features	File Station, Photo Station, Music Station, Video Station, Download Station, Qsync, Notes Station, HD Station, FTP Server, Print Server, VPN Server, VPN Client, Qtiier, Antivirus, Qsirch, Qcontactz, QmailAgent, Qfiling
Streaming Server	DLNA Server, Airplay, Chromecast, iTunes Server
Video Playback and Transcoding	Up to 4K video resolution with graphics acceleration
Remote Access	myQNAPcloud

Accessories

Type	Ordering SKU	Description
Expansion Unit	UX-800P	QNAP 8-bay expansion unit
	UX-500P	QNAP 5-bay expansion unit
Memory	RAM-2GDR3LA0-SO-1866	2GB DDR3L 1866MHz SODIMM RAM
	RAM-2GDR3L-SO-1600	2GB DDR3L 1600MHz SODIMM RAM
	RAM-4GDR3LA0-SO-1866	4GB DDR3L 1866MHz SODIMM RAM
	RAM-4GDR3L-SO-1600	4GB DDR3L 1600MHz SODIMM RAM
M.2 SSD	SSD-M2080-256GB-A01	256GB M.2 2280 SATA 6Gb/s SSD* * Need to be used with QM2 expansion card
Expansion Card	QM2-2S	Supports two M.2 2280/ 22110 SATA SSD
	QM2-2P	Supports two M.2 2280/ 22110 PCIe SSD
	QM2-2S10G1T	Supports two M.2 2280/ 22110 SATA SSD and provides a single-port 10GbE slot
	QM2-2P10G1T	Supports two M.2 2280/ 22110 PCIe SSD and provides a single-port 10GbE slot
	LAN-10G1SR	1-port 10GbE SFP+ adapter
	LAN-10G2SF-MLX	2-port 10GbE SFP+ adapter
	LAN-10G2T-X550	2-port 10GbE 10GBASE-T adapter

QNAP Systems, Inc.

TEL : +886-2-2641-2000 FAX : +886-2-2641-0555 Email: qnapsales@qnap.com
Address : 3F, No.22, Zhongxing Rd., Xizhi Dist., New Taipei City, 221, Taiwan

QNAP may make changes to specification and product descriptions at any time, without notice.

Copyright © 2017 QNAP Systems, Inc. All rights reserved.

QNAP® and other names of QNAP Products are proprietary marks or registered trademarks of QNAP Systems, Inc. Other products and company names mentioned herein are trademarks of their respective holders.

Netherlands (Warehouse Services)

Email: nlsales@qnap.com
TEL: +31(0)107600830

Germany

Email: desales@qnap.com

China

Email: cnsales@qnap.com
TEL: +86-400-028-0079

India

Email: indiasales@qnap.com

US

Email: usasales@qnap.com
TEL: +1-909-595-2782

Thailand

Email: thsales@qnap.com
TEL: +66-2-5415988



51000-024241-RS
201703 (EN) A