

12-bay Thunderbolt™ 3 NAS

TVS-1282T3

Four built-in Thunderbolt™ 3 Ports for Windows and Mac connectivity



4 x Thunderbolt™ 3 ports

Dual 10GBASE-T LAN Ports

2 x M.2 Slots

NEW

Intel 7th-generation Core i5/i7 processors



Highlights of hardware capabilities

- 8GB (up to 64GB) DDR4 2133MHz RAM
- Built-in Thunderbolt™ 3 ports
- 10GbE network interfaces for high-speed file sharing
- Dual SATA 6Gb/s M.2 SSD slots

- Four Thunderbolt™ 3 ports
- M.2 SATA 6Gb/s and SSD slots
- 24/7 acceleration with Qtier and SSD caching
- Instantly find files and documents using Qsirch
- Flexible and comprehensive storage expansion solution
 - ▶ Daisy-chain QNAP Thunderbolt™ 2 with TX-500P/TX-800P
 - ▶ Supports high-speed USB 3.1 10Gbps external storage
 - ▶ VJBOD (Virtual JBOD)
- Provides the perfect storage solution for online video editing

TVS-1282T3 Thunderbolt™ 3 NAS

High-performance Thunderbolt™ 3 NAS for Windows and Mac

Rear View

Side View

Four Thunderbolt™ 3 ports

Industry-leading converged storage with Thunderbolt DAS/NAS/iSCSI connectivity.

Built-in dual 10GBASE-T network ports

Four Gigabit Ethernet ports

Ideal for service binding, port trunking and MPIO configurations.

Three HDMI ports

Triple HDMI output with duplicated and extended desktop display options.

Smart fans for quiet operation

Separately detects CPU and HDD temperatures to dynamically control fan speeds.

3.5 mm audio jack

Connects to speakers or headphones for audio output.

Built-in speakers

Provides direct audio output for multimedia and verbal system warnings.

Four built-in SSD 2.5" slots

Offers flexible configuration in tiered storage and enables cache acceleration.

Tool-less drive tray and installation

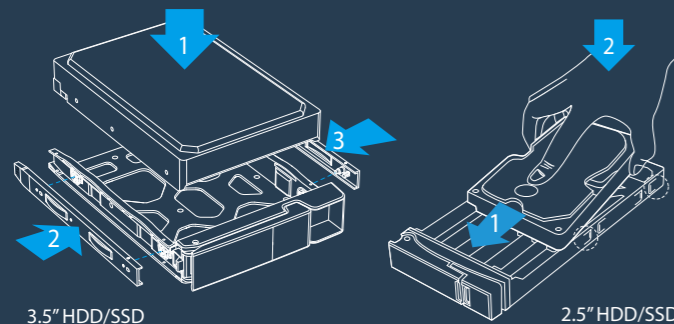

Two built-in M.2 slots*

- ▶ Supports SATA 6Gb/s M.2 SSDs with 2242, 2260, 2280, and 22110 form factors.
- ▶ Allows for high flexibility in tiered storage configurations and enables SSD caching.

* M.2 SSD is optional

DDR4 2133 MHz memory

Supports four DDR4 memory modules with up to 64GB RAM.

7th Generation Intel® Core™ Processor

Features the latest 14nm Intel Core Processors with faster buses to support DDR4, PCIe Gen. 3, and DMI 3.0 for incredible performance and data transmission.

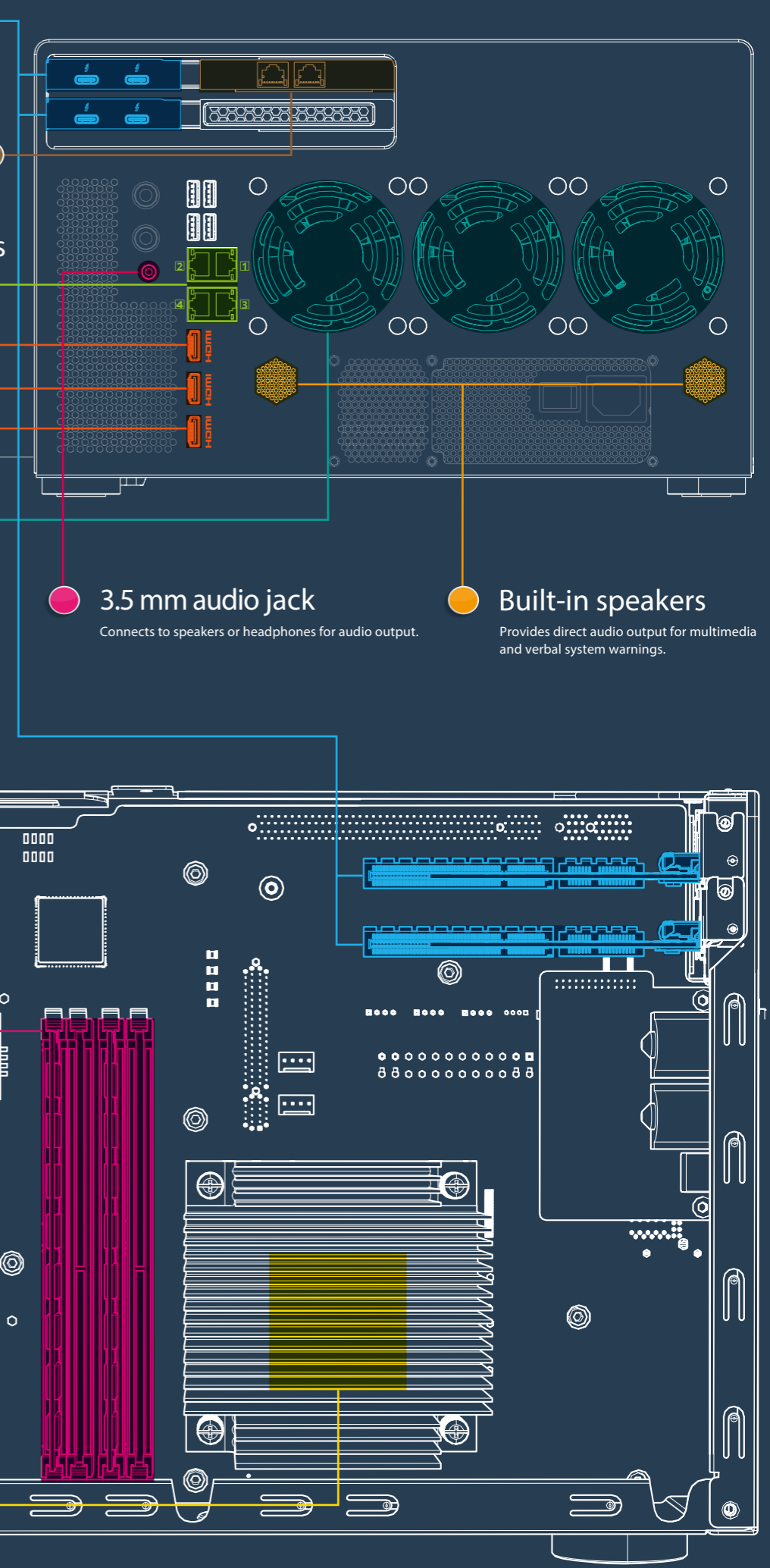

Four Thunderbolt™ 3 Ports NAS Solution



Thunderbolt™ Revolution

With an amazing 40Gbps transmission rate, Thunderbolt™ 3 delivers over twice the bandwidth of Thunderbolt™ 2 and is four times faster than USB 3.1.

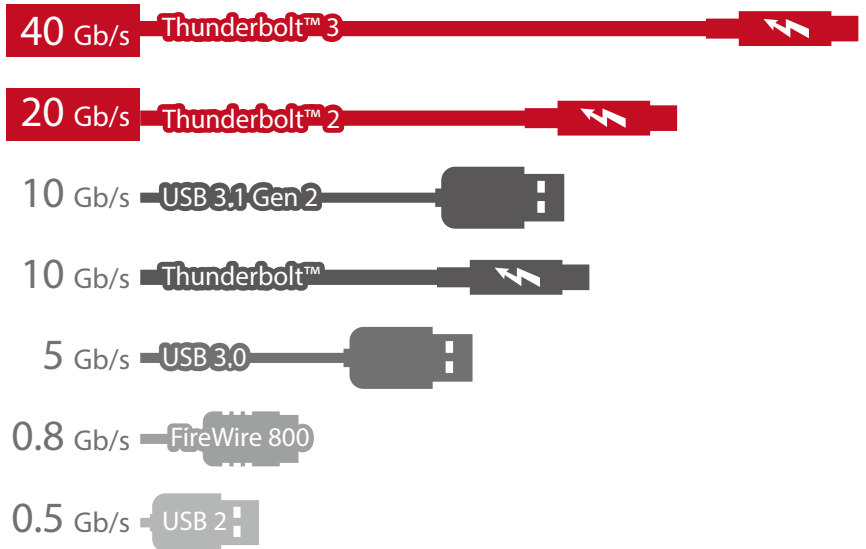

Four Thunderbolt™ 3 ports for more connections

The TVS-1282T3 is the successor to the TVS-871T/TVS-x82T (QNAP's Thunderbolt™ 2 NAS). The TVS-1282T3 features four Thunderbolt 3 ports providing greater connectivity for multiple Mac and Windows computers.

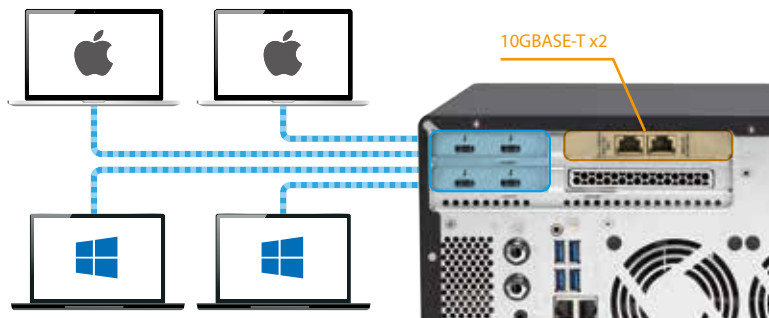

Exceptional performance with Intel 7th Gen. processors and Thunderbolt™ 3

The TVS-1282T3 is equipped with 7th Generation Intel® Core™ i5/Core™ i7 processors and leverages Thunderbolt™ technology for exceptionally high performance. Thunderbolt Networking uses existing network-sharing functionality to connect systems as an Ethernet connection, with Thunderbolt 3 providing up to 1500 MB/s read speeds - over 30% higher performance than Thunderbolt 2.

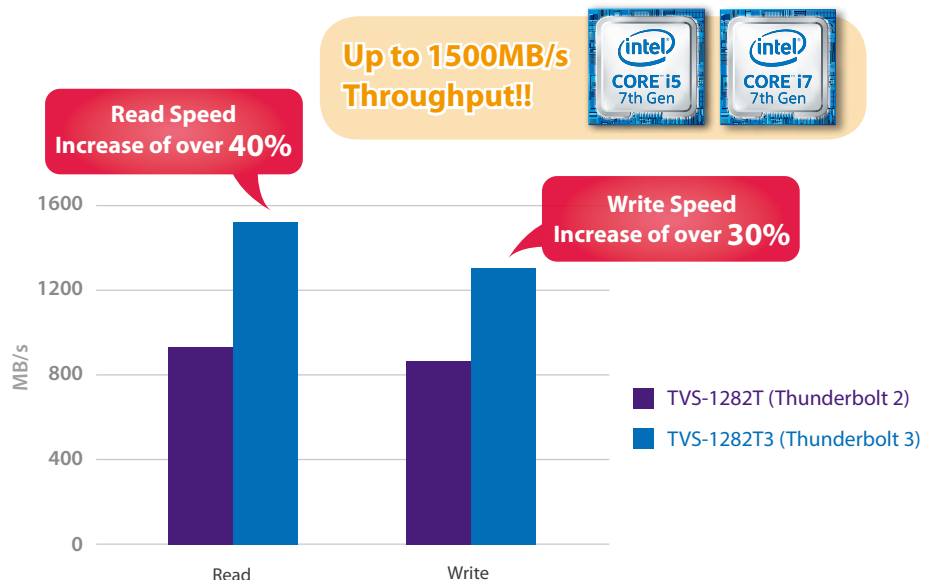

Test environment:
 NAS: TVS-1282T3, Intel core i7-7700 3.6GHz, 32GB memory, INTEL SSDSC2BB240G4 x12, RAID 5
 Host: MSI gaming NB, Intel core i7-6700HQ 2.6GHz, 32GB memory, Windows 10 64-bit
 Test tool: AJA v 12.4.3, 5120x2700 5K RED, 10bit YUV, 16 GB test file.

New Thunderbolt™ 3 cable

Thunderbolt 3 cables use reversible USB Type-C cables for greater convenience and connectivity. However, many USB Type-C cables offer different protocols (USB 3.1, Thunderbolt) and performance levels (20 Gbps, 40 Gbps). In order to tell the difference, Thunderbolt™ 3 cables have a Thunderbolt™ and "3" on one side of the connector.



Where to buy:

Apple Store (online): <http://www.apple.com/shop/product/HKK22ZM/A/belkin-thunderbolt-3-cable-2-m?node=8b>

Thunderbolt 2 to Thunderbolt™ 3 adapter

Devices with Thunderbolt 2 connectors can connect to the TVS-1282T3 by using a suitable adapter.

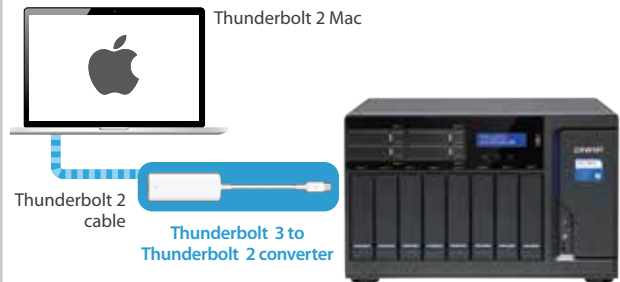

Thunderbolt to Thunderbolt 3 adapter link:

<http://www.apple.com/shop/product/MMEL2AM/A/thunderbolt-3-usb-c-to-thunderbolt-2-adapter?node=8b>

T2E Converter (Thunderbolt to Ethernet)

When upgrading to 10GbE networks, consideration must be given to the many devices that lack the ability to support 10GbE. This often means buying an expensive converter. The TVS-1282T3 features Thunderbolt-to-Ethernet (T2E) functionality that allows Thunderbolt-enabled devices to access 10GbE network resources via the NAS. This eliminates the need for extra converters, and makes it easier to adopt 10GbE infrastructure.

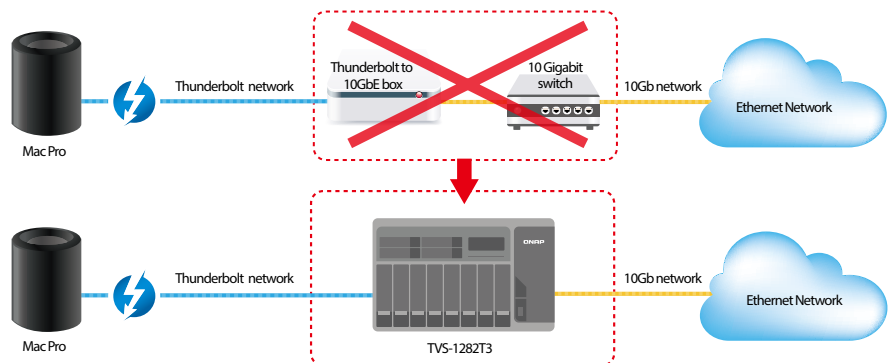

Two Thunderbolt network access modes

1 T2E Converter

Through Thunderbolt to Ethernet virtual switch network configuration and interface card binding, you can create a two-way network transmission environment. QNAP NAS helps you easily bridge physical and virtual interface cards, and is your versatile Thunderbolt Converter.

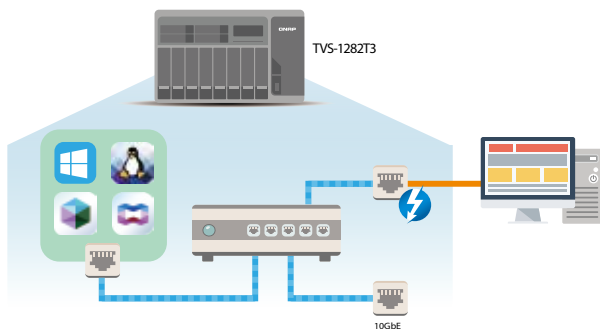

2 Thunderbolt Residential Gateway (NAT)

By enabling the NAT service of the Thunderbolt Virtual Switch in Qfinder Pro, Thunderbolt devices can be connected to all network ports and virtual machines through the NAS, without configuring complicated network settings.

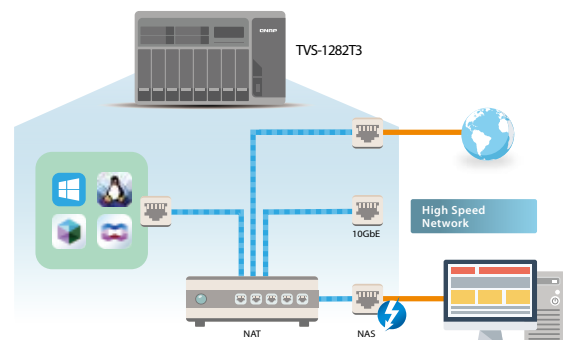

Note: Thunderbolt devices under a NAT architecture are unable to support end-to-end host connections and some of the Internet protocols.

2 Network Technologies

Thunderbolt™ 3 uses industry-standard networking technologies for running all network services (such as file sharing, FTP and other services). The TVS-1282T3 can also simultaneously run general Ethernet services in addition to the Thunderbolt™ 3 network, completely independently and with no bandwidth interference.

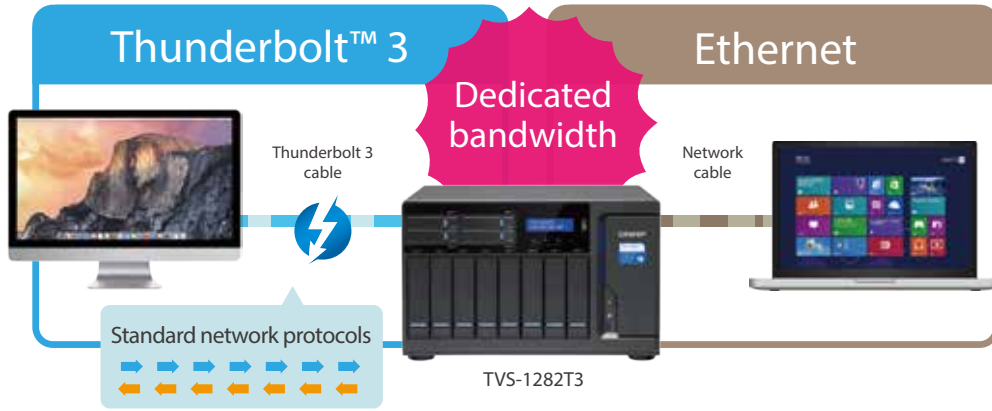

3 Storage technologies

1 Direct-attached storage (Thunderbolt NAS)

Plug and play without IP settings. Provides high-speed access to shared folders over a direct Thunderbolt 3 connection to Mac or Windows PC.

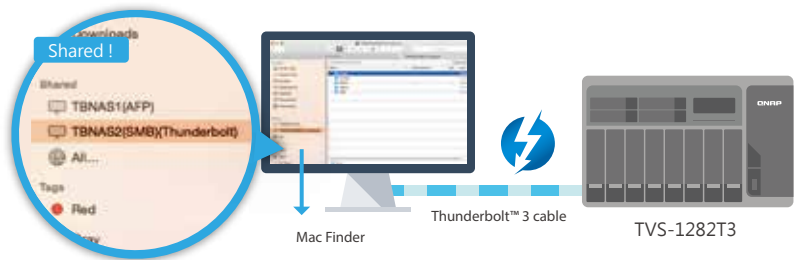

2 Network-attached storage (NAS)

Cross-platform access for high-speed backup and file storage.

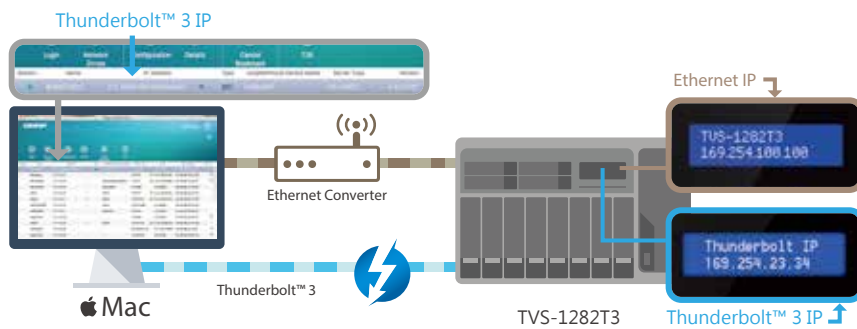

3 iSCSI SAN

Native support for iSCSI-SAN connections for building high-speed storage networks

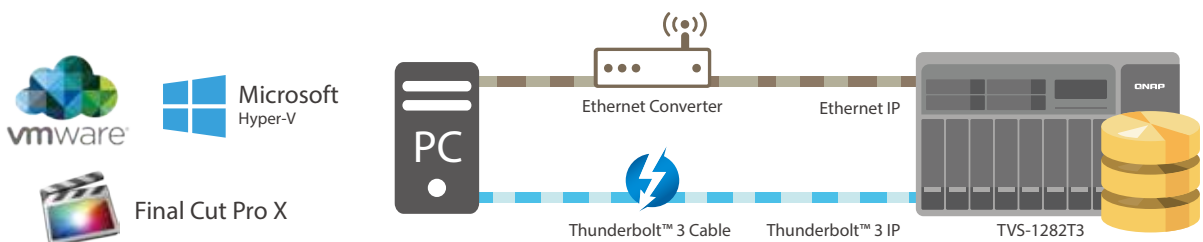

Realizing super-high-speed video editing with TVS-1282T3

The QNAP TVS-1282T3 is the world's first Thunderbolt™ 3 NAS and was designed to help media and entertainment professionals meet the massive data demands of fully-digital workflows. High performance and broad compatibility help deliver time and cost savings, from image acquisition through post production. The TVS-1282T3 delivers powerful and stable throughput for real-time non-linear video editing, and also allows multi-track video editing with the lowest latency. Up to four Thunderbolt™-compatible devices can connect to the TVS-1282T3 to simultaneously process real-time video editing. Furthermore, a 4K monitor can connect to the TVS-1282T3 via HDMI to directly play 4K videos for instant preview of the final work. With 40 Gbps (bi-directional for data & display) the ability to daisy-chain multiple devices, and incredibly low latency, the QNAP TVS-1282T3 is an ideal complement for professional media creators.

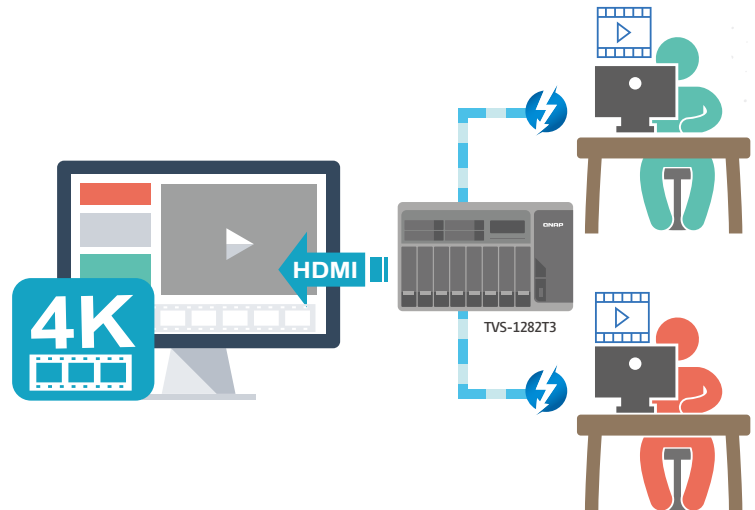

Final Cut Pro X

With Qfinder Pro for Mac, Final Cut Pro X users can easily import videos from the connected TVS-1282T3 to Mac workstations and process real-time 4K media editing. Qfinder Pro can guide users through the process of mounting shared folders using NFS.

Users can also create an iSCSI LUN with a target on the TVS-1282T3 and mount the target on a Mac for storage. An iSCSI Initiator (ATTO Xtend SAN iSCSI Initiator or SNS globalSAN® iSCSI Initiator) must be installed to connect to the iSCSI target.

Adobe Premiere Pro

Premiere Pro is the industry standard for professional video editing and provides both Windows and Mac users with advanced video production tools for transcoding, editing visual effects, audio, and color correction. Professional video editors can perform real-time 4K content editing with the TVS-1282T3 using either the SMB or NFS protocol.



Hardware Specifications



NAS Model	TVS-1282T3	
Ordering SKUs	TVS-1282T3-i5-16G	TVS-1282T3-i7-32G TVS-1282T3-i7-64G
CPU	Quad-core Intel® Core™ i5-7500 3.4 GHz processor	Quad-core Intel® Core™ i7-7700 3.6 GHz processor
Memory	Total DIMM slots: 4 Maximum memory: 64GB (16GB x4) Note: The pre-installed memory modules may need to be replaced when expanding the memory.	
	System memory: 16GB DDR4 RAM Memory modules pre-installed: 8GB x2	TVS-1282T3-i7-32G: System memory: 32GB DDR4 RAM Memory modules pre-installed: 8GB x4 TVS-1282T3-i7-64G: System memory: 32GB DDR4 RAM Memory modules pre-installed: 16GB x4
Flash Memory	512MB DOM	
M.2 Slots	2 x M.2 2242/2260/2280/22110 SATA 6Gb/s slots Note: M.2 SSD is not included in the product package.	
Drive Trays	4 x 2.5" SSD 8 x 2.5"/3.5" hard drive or SSD	
Drive Interface	SATA 6Gbps/3Gbps	
Thunderbolt Ports	Thunderbolt™ 3 port x4	
USB	5 x USB 3.0 ports	
Ethernet	2 x 10GbE ports, 4x GbE ports	
Video Output	3	
Audio Input	2 x 6.3 mm microphone jacks	
Audio Output	2 x built-in speakers, 1 x 3.5mm Line-out jack Note: Only one of the above audio output ports can work at a time. If a speaker is connected, the sound will output through the speaker.	
LED Indicators	System status, 2.5" SSD, M.2 SSD, 3.5" HDD/SSD	
Buttons	Power, USB One-touch-copy backup, Reset	
System Warning	Buzzer	
Form Factor	Tower	
Dimensions	234.6 x 369.9 x 319.8 mm (H x W x D)	
Weight	Net (NAS only): 11.55 kg/25.46 lb Gross (with the package and accessories): 13.65 kg/30.09 lb	
Sound Level (dB)	Sound pressure (LpAm) (bystander position): 21.6 dB (with 12 x Seagate ST2000VN000-1HJ164 HDDs installed)	
Temperature	0 to 40°C (32 to 104°F)	
Relative Humidity	5~95% non-condensing, wet bulb: 27°C	
Power Supply	Input: 100-240V~, 3-1.5A, 60-50Hz, Output: 250W	
PCIe Expansion Slots	3 (1 x "PCIe Gen3 x8"; 2 x "PCIe Gen3 x4") Note: PCIe slots are occupied by two Thunderbolt™ cards and a 10GbE adapter.	
Fan	System: 3 x 8 cm quiet cooling fan CPU: 2 x 9 cm fan	System: 3 x 8 cm quiet cooling fan CPU: 2 x 9 cm fan

★ Model specifications are subject to change without notice. Please refer to www.qnap.com for the latest information.

QNAP SYSTEMS, INC.

TEL : +886-2-2641-2000 FAX: +886-2-2641-0555 Email: qnap-sales@qnap.com

Address : 3F, No.22, Zhongxing Rd., Xizhi Dist., New Taipei City, 221, Taiwan

QNAP may make changes to specification and product descriptions at any time, without notice.

Copyright © 2017 QNAP Systems, Inc. All rights reserved.

QNAP® and other names of QNAP Products are proprietary marks or registered trademarks of QNAP Systems, Inc.

Other products and company names mentioned herein are trademarks of their respective holders.

Netherlands (Warehouse Services)

Email: nlsales@qnap.com
TEL: +31(0)107600830

China

Email: cnsales@qnap.com
TEL: +86-400-028-0079

Thailand

Email: thsales@qnap.com
TEL: +66-2-5415988

Japan

Email: jpsales@qnap.com
FAX: 03-6435-9686

US

Email: usasales@qnap.com
TEL: +1-909-595-2782

India

Email: indiasales@qnap.com

Germany

Email: desales@qnap.com

France

Email: frsales@qnap.com



51000-024255-RS
201703 (EN) B